

筒射灯

规格书

K2E55L2

— KING 2 系列



【基本参数】

- 工艺材质: ADC12, 表面喷涂
- 电源安装: 外置
- 防护等级: IP20/IP54
- 成品色温: 2700/3000/3500/4000K/2700-6500K 可选
- 成品显指: >90
- 光源色容差: <3 Step
- 光束角: 15°/24°/36°/45° 可选
- UGR值: (X=4H, Y=8H): ≤8(15°/24°/36°)、≤16(45°)
- 发光方向: 向下
- 调光方式: 非调光/0-10V/可控硅/DALI 可选
- 输入电压: AC220-240V
- 工作温度: -15°C~40°C
- 产品应用: 室内
- 安装方式: 嵌入式
- 产品认证: CE、UKCA、ROHS、Reach
- 质保年限: 5 years



【外环颜色】



黑色



白色

【反射器类型】



圆孔



针孔



椭圆孔

【反射器颜色】



哑黑



哑白



香槟金



镜面



黑铬

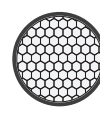

蜂窝网

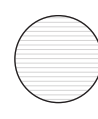

拉伸膜

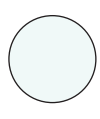

柔光膜

【光学配件】

【产品机械参数】

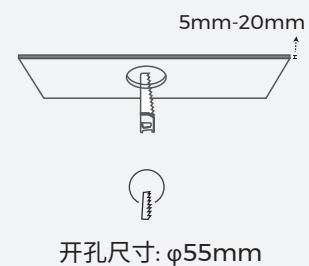
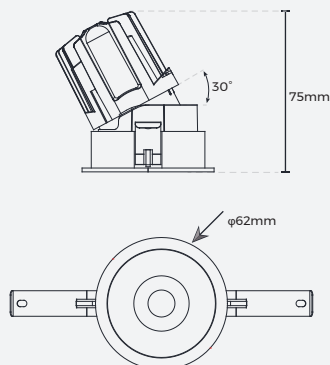
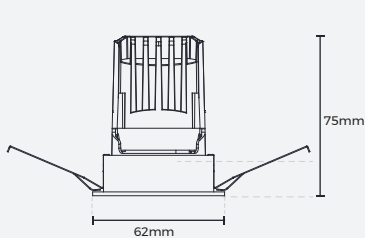

【灯具参数】

版本	商城型号	开孔尺寸 (mm)	LED 输入电压 (V)	LED 输入电流 (mA)	典型功率 (W)	显指	光束角	色温	流明 (lm)
常规	K2E55L2	φ55	DC36	150	6	>90	15°	3000K	300
							24°	3000K	440
							36°	3000K	425
							45°	3000K	450
				200	8		15°	3000K	385
							24°	3000K	560
							36°	3000K	545
							45°	3000K	575
				250	10		15°	3000K	450
							24°	3000K	680
							36°	3000K	670
							45°	3000K	700
300	12	15°	3000K	505					
		24°	3000K	805					
		36°	3000K	790					
		45°	3000K	815					
CCT 可调	K2E55L2	φ55	DC36	200	8	>90	24°	2700K	385
							36°		385
							45°		415
							24°	4000K	480
							36°		480
							45°		505
							24°	6500K	455
							36°		455
							45°		480
				250	10		24°	2700K	460
							36°		460
							45°		480
							24°	4000K	570
							36°		570
							45°		600
250	10	24°	6500K	550					
		36°		550					
		45°		580					

CCT Tunable	K2E55L2	φ55	DC36	300	12	>90	24°	2700K	480
							36°		505
							45°		540
							24°	4000K	650
							36°		650
							45°		695
							24°	6500K	600
							36°		625
							45°		650

Note:

1. 以上参数基于Ra90,3000K光源进行测试;
2700K 光效 & 光通量=3000K*0.95
3500K 光效 & 光通量=3000K*1.03
4000K 光效 & 光通量=3000K*1.05
2. 输入电压和额定电流皆为光源参数
3. 光源光源品牌是科锐.
4. 驱动电源品牌是伊戈尔或艾迪明.
5. 上述参数属于“圆孔”反射器类型,而“针孔”反射器类型和“椭圆孔”反射器类型的光效会比“圆孔”反射器类型低 10%.
6. 采用以下任何一种光学配件——蜂窝网、拉伸膜或柔光膜,都会降低光效、防眩指数以及光束角度.
7. 光通量允许有±10%的误差范围.
8. 上述参数均为典型值.

【产品配光曲线】

- 常规款

· 典型功率: 6W

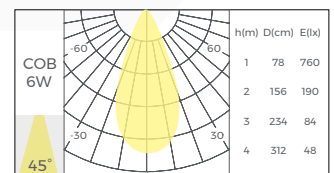
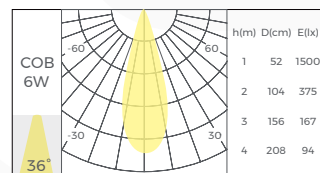
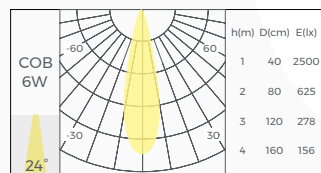
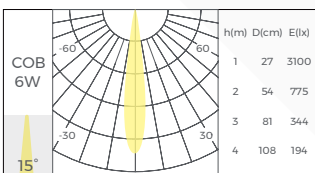

· 典型功率: 8W

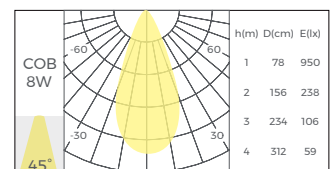
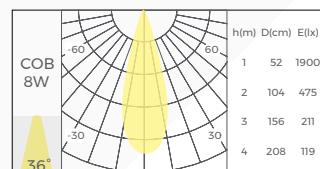
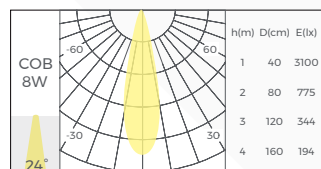
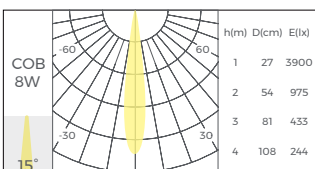

· 典型功率: 10W

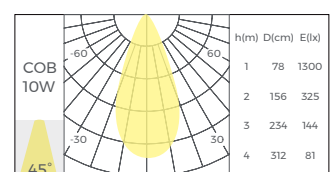
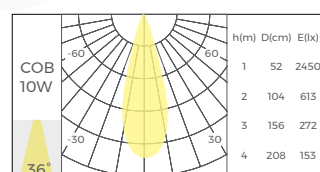
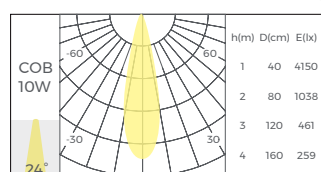
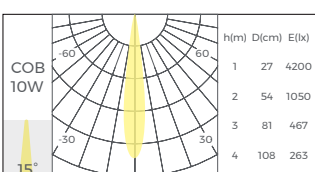

·典型功率: 12W

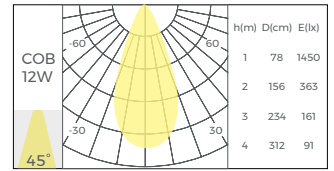
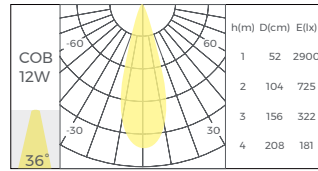
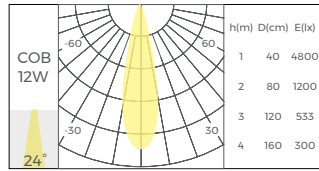
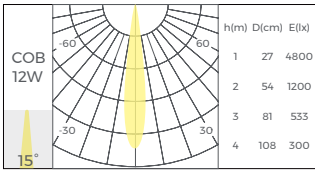

- CCT 可调

·典型功率: 8W

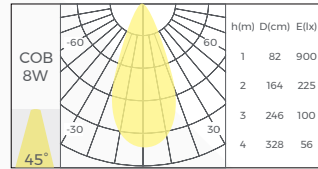
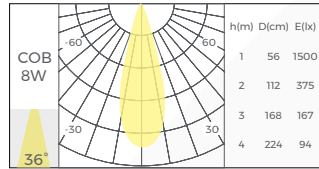
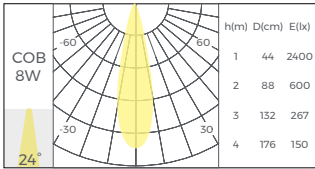

·典型功率: 10W

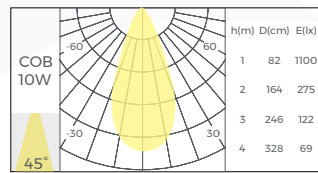
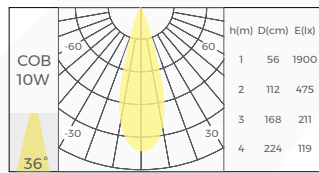
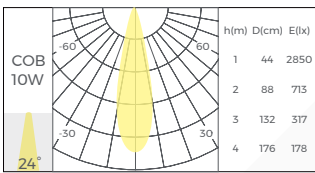

·典型功率: 12W

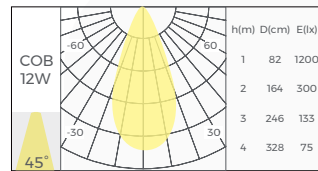
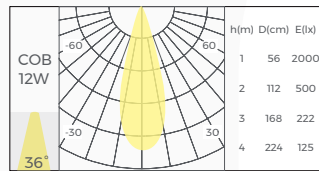
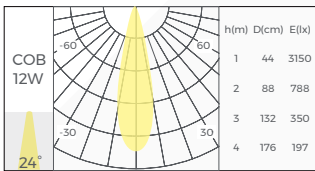

Note:

1. 中心光强值 = 1米处的最大发光强度值;
 2. N米最大发光光强值=中心光强值/N²;
- 例如:2米最大发光强度值 = 中心光强值/2²;

【包装信息】

产品型号	内盒尺寸 (mm/盒)	产品数量 /盒	产品 数量/箱	净重 (kg/盒)	净重 (kg/箱)	毛重 (kg)	外箱尺寸 (mm/箱)
DL-K2E55L2-XXX	168*144*100	1	48	0.27	13	19	592*519*422

【注意事项】

- 1、非专业人员,禁止对产品进行安装、拆卸和维修;灯具用于照明,并根据电力法律法规和安装说明进行安装/拆除.
- 2、在安装过程中请避免对产品进行刮花、扭曲以及不规则的弯曲,否则会有可能给产品造成无法修复的损伤.
- 3、裁剪时请使用专业裁剪工具.
- 4、严禁使用任何酸性、碱性粘接剂固定产品.
- 5、本产品不能应用于户外或海边环境.